

Mfg. No: 020726-00
3,300 PSI PowerBoss

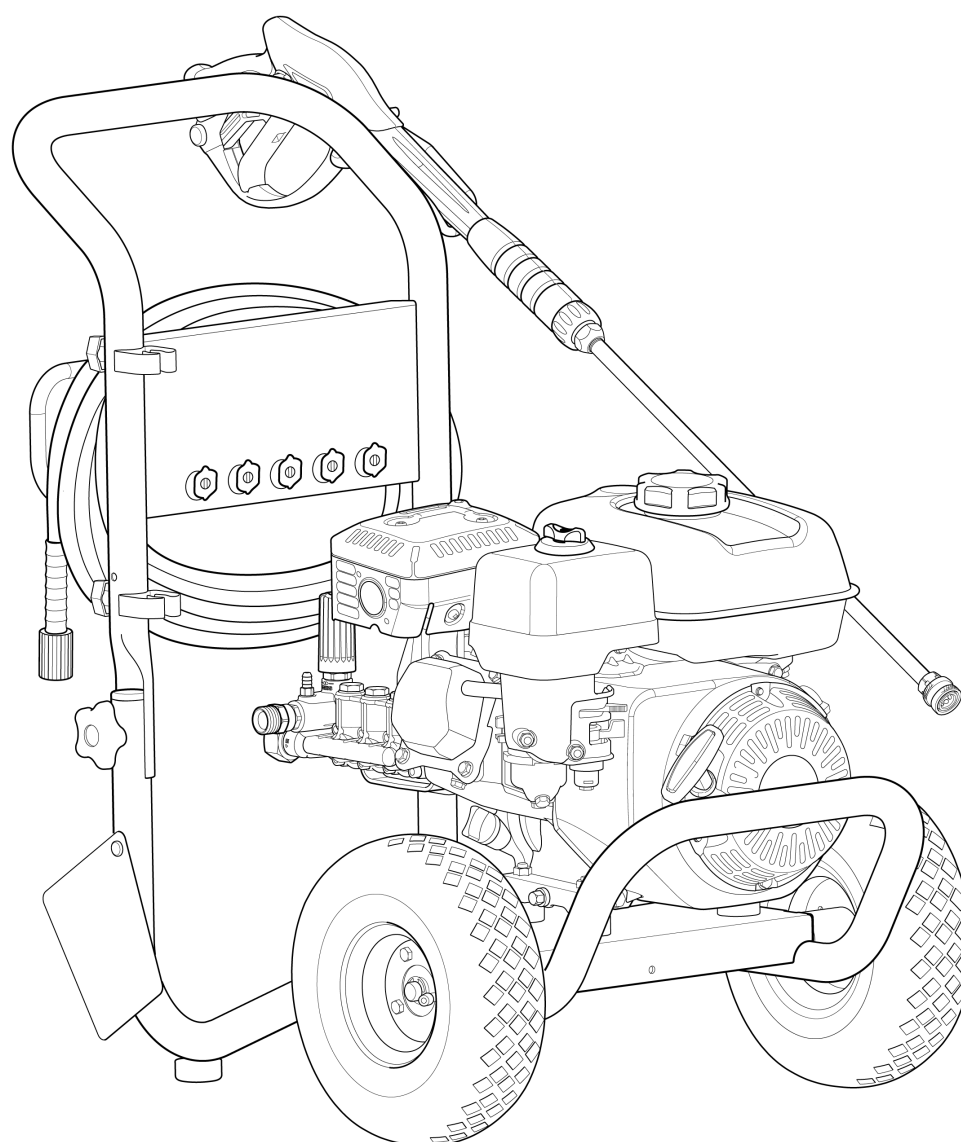

Model Components	Page
Main Unit (80028467).....	4
Pump (80025170).....	6
Torque Specification Chart.....	8

Not For
Reproduction

Main Unit (80028467)

Note: Unless noted otherwise, use the standard torque specifications

Mfg. No: 020726-00

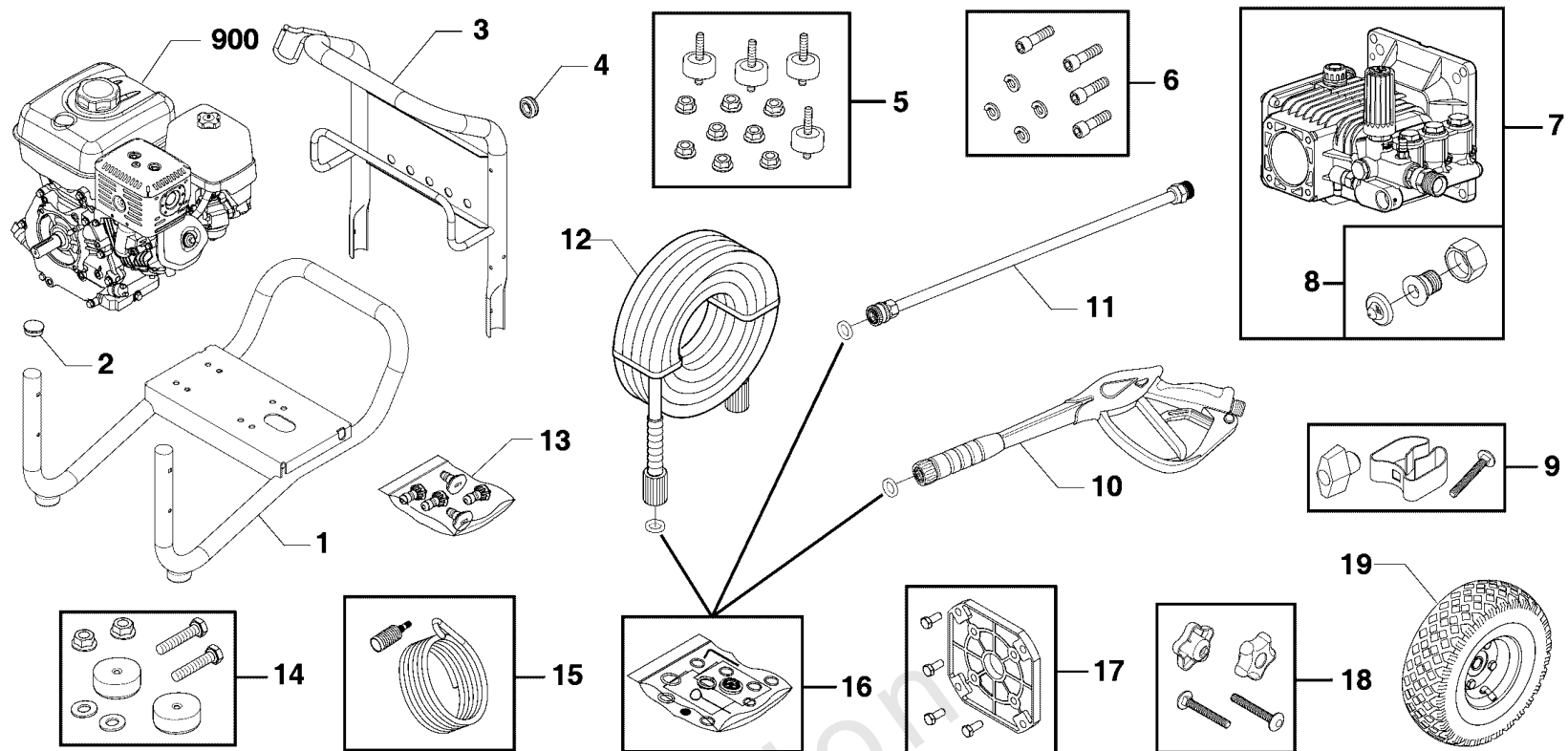

Not For
Reproduction

Main Unit (80028467)

REF NO	PART NO	QTY	DESCRIPTION
1	771926		BASE -(Includes Item 2)
2	189332GS		PLUG, Hole
3	709498		HANDLE
4	30809GS		GROMMET
5	192134GS		KIT, Vibration Mount
6	709492		KIT-HARDWARE PUMP MOUNTING
7	771795		PUMP
8	199310GS		KIT, Connector, Hose, Garden
9	709493		KIT-CLIP
10	704312		GUN
11	706595		WAND-QC
12	771932		HOSE
13	771928		KIT-QC NOZZLES
--	195983AAGS		NOZZLE-QC RED
--	195983ABGS		Nozzle, QC, Yellow
--	195983ACGS		NOZZLE, QC Green
--	195983AMGS		NOZZLE, QC, White
--	198841GS		NOZZLE, QC, Black
14	192310GS		KIT, Vibration Mount
15	192796GS		KIT, Chem Hose & Filter
16	705001		KIT-O-RING
17	771797		KIT - ENGINE FLANGE
18	771929		KIT-HARDWARE, HANDLE
19	209885GS		WHEEL
900	-----		*ENGINE - HONDA, GX200, HS, RS 50
--	191267ABGS		AXLE -(Not Illustrated)
--	23139DGS		KEY -(Not Illustrated)
--	771925		DECAL-UNIT -(Not Illustrated)
--	100005		OIL-4 CYCLE 30W 18OZ. -(Not Illustrated)
--	703977		E-RING -(Not Illustrated)
--	705851		DECAL-Warning Spark -(Not Illustrated)
--	707165		TAG-WARNING, ENG -(Not Illustrated)
--	6039		PUMP Saver -(Optional Accessory)
--	6059		PERFECT MIX MULTI-PURPOSE WASH -(Optional Accessory)
--	6160		Project Pro® PerfectMix Concrete, Brick, And Tile Cleaner -(Optional Accessory)

Footnotes:

(Note:* For parts and warranty contact American Honda Motor Company at 1-800-426-7701 or visit www.honda-engines.com for a dealer locator.)

* Service Kit includes all service parts

Pump (80025170)

Note: Unless noted otherwise, use the standard torque specifications

Mfg. No: 020726-00

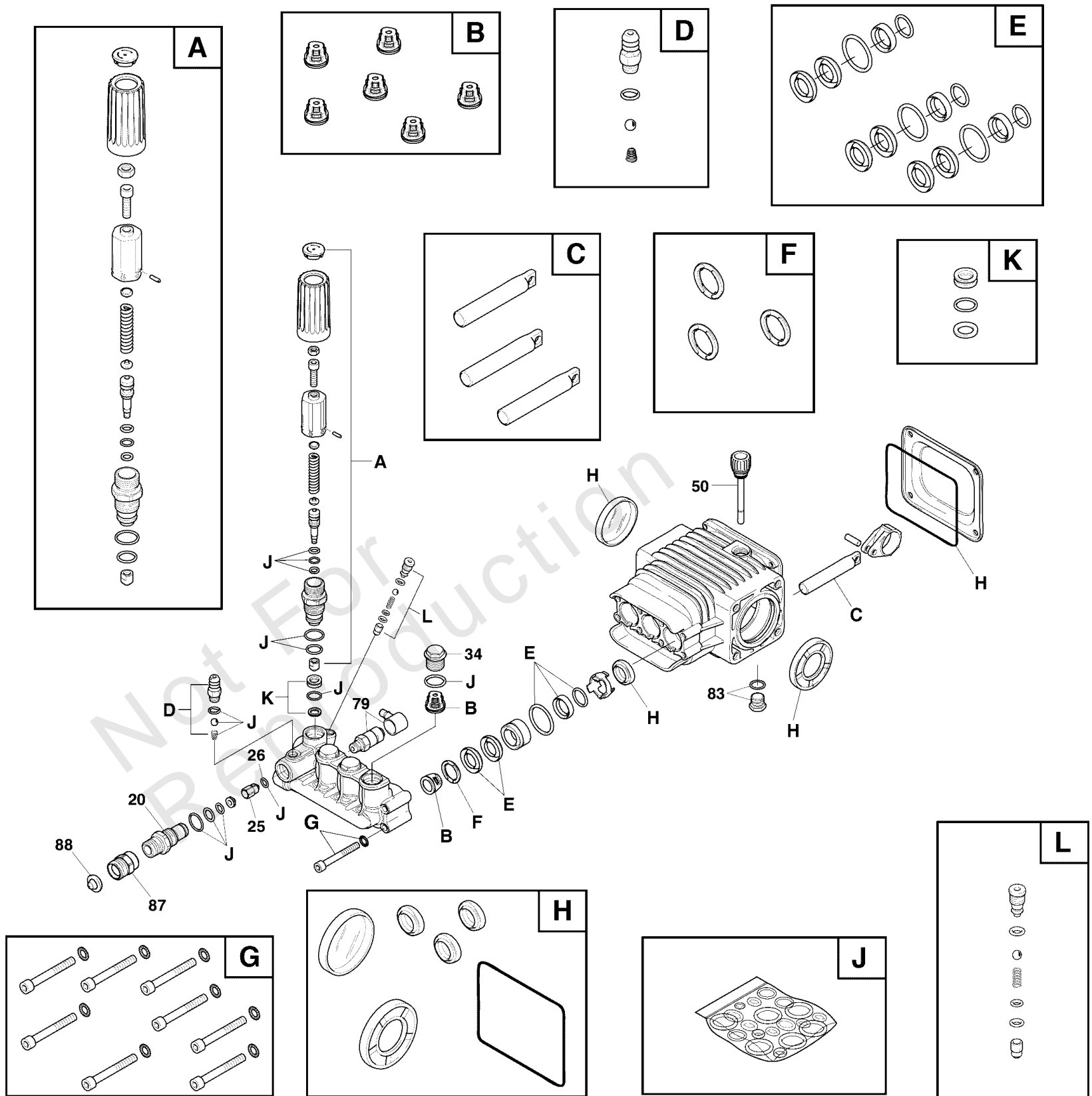

Pump (80025170)

REF NO	PART NO	QTY	DESCRIPTION
20	198851GS	1	INJECTOR, Detergent 3/8NPT
25	204860GS	1	JET
26	204859GS	1	O-RING
34	317334GS	1	PLUG
50	198849GS	1	CAP, Oil Dispstick
79	208673GS	1	VALVE, Thermal Relief
83	203034GS	1	PLUG-DRAIN
87	771695	1	ADAPTER
88	B2384GS	1	FILTER, Garden Hose
A	198736GS	1	* KIT, Unloader -(Service kit includes all parts shown within the box.)
B	705928	1	*KIT, Valves -(Service kit includes all parts shown within the box.)
C	198844GS	1	* KIT, Piston -(Service kit includes all parts shown within the box.)
D	192914GS	1	* KIT, Chemical Injection -(Service kit includes all parts shown within the box.)
E	198845GS	1	* KIT, Water Seals -(Service kit includes all parts shown within the box.)
F	198848GS	1	* KIT, Support Ring -(Service kit includes all parts shown within the box.)
G	198852GS	1	KIT, Hardware, Pump Head -(Service kit includes all parts shown within the box.)
H	198846GS	1	* KIT, Oil Seals -(Service kit includes all parts shown within the box.)
J	198847GS	1	* KIT, O-Ring Maintenance -(Service kit includes all parts shown within the box.)
K	202902GS	1	* KIT, Unloader Seat -(Service kit includes all parts shown within the box.)
L	202800GS	1	* KIT, Unloader -(Service kit includes all parts shown within the box.)
--	6039		PUMP Saver -(Optional Accessories Not Illustrated)
--	6059		PERFECT MIX MULTI-PURPOSE WASH -(Optional Accessories Not Illustrated)
--	6160		Project Pro® PerfectMix Concrete, Brick, And Tile Cleaner -(Optional Accessories Not Illustrated)

Hardware Identification & Torque Specifications

Torque Specification Chart								
FOR STANDARD METRIC MACHINE HARDWARE (Tolerance ± 20%)								
Property Class	5.6		8.8		10.9		12.9	
	Class 5.6		Class 8.8		Class 10.9		Class 12.9	
Size Of Hardware	in/lbs	Nm.	in/lbs	Nm.	in/lbs	Nm.	in/lbs	Nm.
	ft/lbs		ft/lbs		ft/lbs		ft/lbs	
M3	5.88	.56	13.44	1.28	19.2	1.80	22.92	2.15
M4	13.44	1.28	30.72	2.90	43.44	4.10	52.56	4.95
M5	26.4	2.50	60.96	5.75	5.97	8.10	7.15	9.7
M6	44.64	4.3	7.3	9.9	10.3	14	12.1	16.5
M7	5.2	7.1	12.1	16.5	16.9	23	19.9	27
M8	7.7	10.5	17.7	24	25	34	29	40
M10	15	21	35	48	50	67	59	81
M12	26	36	61	83	86.2	117	103	140
M14	42	58	101	132	136	185	162	220
M16	64	88	147	200	210	285	250	340
M18	89	121	202	275	287	390	346	470
M20	126	171	290	390	405	550	486	660
M22	169	230	390	530	559	745	656	890
M24	217	295	497	375	708	960	840	1140
M27	320	435	733	995	1032	1400	1239	1680
M30	435	590	995	1350	1401	1900	1681	2280
M33	590	800	1349	1830	1902	2580	2278	3090
M36	759	1030	1740	2360	2441	3310	2935	3980
M39	988	1340	2249	3050	3163	4290	3798	5150

Torque Specification Chart						
FOR STANDARD MACHINE HARDWARE (Tolerance ± 20%)						
Hardware Grade	No Marks		SAE Grade 5		SAE Grade 8	
	SAE Grade 2		SAE Grade 5		SAE Grade 8	
Size Of Hardware	in/lbs	Nm.	in/lbs	Nm.	in/lbs	Nm.
	ft/lbs		ft/lbs		ft/lbs	
8-32	19	2.1	30	3.4	41	4.6
8-36	20	2.3	31	3.5	43	4.9
10-24	27	3.1	43	4.9	60	6.8
10-32	31	3.5	49	5.5	68	7.7
1/4-20	66	7.6	8	10.9	12	16.3
1/4-28	76	8.6	10	13.6	14	19.0
5/16-18	11	15.0	17	23.1	25	34.0
5/16-24	12	16.3	19	25.8	29	34.0
3/8-16	20	27.2	30	40.8	45	61.2
3/8-24	23	31.3	35	47.6	50	68.0
7/16-14	30	40.8	50	68.0	70	95.2
7/16-20	35	47.6	55	74.8	80	108.8
1/2-13	50	68.0	75	102.0	110	149.6
1/2-20	55	74.8	90	122.4	120	163.2
9/16-12	65	88.4	110	149.6	150	204.0
9/16-18	75	102.0	120	163.2	170	231.2
5/8-11	90	122.4	150	204.0	220	299.2
5/8-18	100	136	180	244.8	240	326.4
3/4-10	160	217.6	260	353.6	386	525.0
3/4-16	180	244.8	300	408.0	420	571.2
7/8-9	140	190.4	400	544.0	600	816.0
7/8-14	155	210.8	440	598.4	660	897.6
1-8	220	299.2	580	788.8	900	1,244.0
1-12	240	326.4	640	870.4	1,000	1,360.0

The guides and ruler furnished below are designed to help you select the appropriate hardware.



Nut, M8

Thread Diameter (mm)

Inside Diameter (in) Threads per inch

Nut, 1/2-16



Screw, M8- 1.25 x 25

Thread Diameter (mm) Distance between threads (mm) Body Length (mm)

Body Diameter Threads per inch Body Length (in)

Screw, 1/2- 16 x 2



Standard Hardware Sizing

When a washer or nut is identified as 1/2" (M8), this is the *Nominal size*, meaning the *inside diameter* is 1/2 inch (8mm metric thread diameter); if a second number is present it represents the *threads per inch* (distance between threads).

When bolt or capscrew is identified as 1/2 - 16 x 2" (M8 - 1.25 x 50), this means the *Nominal size*, or body diameter is 1/2 inch (8mm metric thread diameter), the second number, 16, represents the *threads per inch*, (*distance between threads*). The final number is the body length of the bolt or screw, 2 inches (50mm).

NOTES

- These torque values are to be used for all hardware excluding: locknuts, self-tapping screws, thread forming screws, sheet metal screws and socket head setscrews.
- Recommended seating torque values for locknuts:
 - for prevailing torque locknuts - use 65% of grade 5 torques.
 - for flange whizlock nuts and screws - use 135% of grade 5 torques.
- Unless otherwise noted on assembly drawings, all torque values must meet this specification.

Common Hardware Types

Hex Head Capscrew



Washer



Carriage Bolt



Hex Nut

Wrench & Fastener Size Guide

1/4" Bolt or Nut Wrench—7/16"	5/16" Bolt or Nut Wrench—1/2"	3/8" Bolt or Nut Wrench—9/16"	7/16" Bolt or Nut Wrench (Bolt)—5/8" Wrench (Nut)—11/16"	1/2" Bolt or Nut Wrench—3/4"
M6 Bolt or Nut Wrench—10mm	M8 Bolt or Nut Wrench—13mm	M10 Bolt or Nut Wrench—17mm	M12 Bolt or Nut Wrench—19mm	M14 Bolt or Nut Wrench—22mm

